



Series MLW

Snap-in Mount Power Rated Switches

TYPICAL SWITCH ORDERING EXAMPLE

MLW30

2

5

12

DC

1A

POLES

1	SPDT
2	SP3T DPDT

CIRCUITS

2	ON	NONE	ON
3	ON	OFF	ON
5	ON	NONE	(ON)
8	(ON)	OFF	(ON)
9	ON	OFF	(ON)
0	ON	ON	ON

() = Momentary

LAMPS

Incandescent & Neon Lamps	
00	No Lamp
06	6 Volt
12	12 Volt
18	18 Volt
24	24 Volt
28	28 Volt
N	110 Volt (not suitable w/green & blue)

CAP TYPES/COLORS

Rocker	
RA	Black
RB	White
RC	Red
RD	Orange
RE	Yellow
RF	Green
RG	Blue
Paddle	
PA	Black
PB	White
PC	Red
PD	Orange
PE	Yellow
PF	Green
PG	Blue
Design Rocker	
DB	White
DC	Red
DD	Orange
DF	Green
DG	Blue

BEZELS/COLORS

20mm Wide	
1A	Black
1B	White
1C	Red
1D	Orange
1E	Yellow
1F	Green
1G	Blue
1H	Gray
23.8mm Wide	
2A	Black
2B	White
2C	Red
2D	Orange
2E	Yellow
2F	Green
2G	Blue
2H	Gray

IMPORTANT:

Switches are supplied without UL & CSA marking unless specified. Specific models & ratings noted on General Specifications page.



Double Element LED Colors

C	Red
E	Yellow
F	Green

LED Rocker

LB	White
LC	Red
LE	Yellow
LF	Green

Sculptured Rocker

SB	White
SC	Red
SE	Yellow
SF	Green

DESCRIPTION FOR TYPICAL ORDERING EXAMPLE

MLW3025-12-DC-1A

12-volt Incandescent Lamp

Black 20mm Wide Bezel

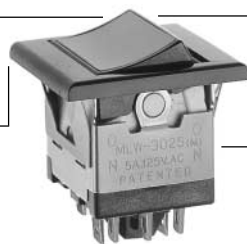

Design Cap
(Black Rocker Base with Red Filter)

DPDT
ON-NONE-(ON)
Circuit



GENERAL SPECIFICATIONS

Electrical Capacity (Resistive Load)

Power Level: 5A @ 125V AC, 3A @ 250V AC, & 3A @ 30V DC

Other Ratings

Contact Resistance: 10 milliohms maximum
Insulation Resistance: 200 megohms minimum @ 500V DC
Dielectric Strength: 1,000V AC minimum between contacts; 1,500V AC minimum between contacts & case
Mechanical Life: 30,000 operations minimum
Electrical Life: 10,000 operations minimum
Nominal Operating Force: 1014 grams for rockers & 450 grams for paddles
Angle of Throw: 26°

Materials & Finishes

Housing: Stainless steel
Movable Contacts: Silver alloy
Stationary Contacts: Silver
Base: Phenolic resin
Common Terminal: Copper with silver plating
End Terminals: Copper with silver plating
Lamp Terminals: Phosphor bronze with with nickel plating

Environmental Data

Operating Temp Range: -10°C through +50°C (+14°F through +122°F)
Humidity: 90 ~ 95% humidity for 96 hours @ 40°C (104°F)
Vibration: 10 ~ 55Hz with peak-to-peak amplitude of 1.5mm traversing the frequency range & returning in 1 minute; 3 right angled directions for 2 hours
Shock: 50g acceleration (tested in 3 right angled directions, with 3 shocks in each direction)

Installation

Cap Installation Force: 1.0 kg (2.2 lbs) for AT405 cap;
2.0 kg (4.4 lbs) for AT426 cap
Soldering Time & Temperature: 3 seconds @ 350°C or 5 seconds @ 270°C
Process Seal: Not available

Standards & Certifications

UL Recognized: All models recognized at 5A @ 125V AC & 3A @ 250V AC; UL File No. E44145
CSA Certified: All models recognized at 5A @ 125V AC & 3A @ 250V AC; CSA File No. LR23535



Series MLW

Snap-in Mount Power Rated Switches

POLES & CIRCUITS

		Rocker Position () = Momentary			Connected Terminals			Throw & Power/Lamp Schematics
Pole	Model	Up	Center	Down	Up	Center	Down	
SP	MLW3012 MLW3013 MLW3015 MLW3018 MLW3019	ON ON ON (ON) ON	NONE OFF NONE OFF OFF	ON ON (ON) (ON) (ON)	2-3	OPEN	2-1	Notes: Terminal numbers are not actually on the switch. Lamp circuit is isolated & requires an external power source. SPDT
DP	MLW3022 MLW3023 MLW3025 MLW3028 MLW3029	ON ON ON (ON) ON	NONE OFF NONE OFF OFF	ON ON (ON) (ON) (ON)	2-3 5-6	OPEN	2-1 5-4	DPDT

For 3 Throw (3-On)

Pole	Model	Up	Center	Down	Connected Terminals & Schematics			External Connection
SP	MLW3020	ON	ON	ON				The SP3T model utilizes a double pole base.
With External Connection					2-6	2-4	2-1	External connection must be made during field installation.
Without External Connection					2-3 5-6	2-3 5-4	2-1 5-4	

TERMINALS

Power Terminals

1.1mm x 2mm oblong holes accommodate one solid 18-gauge wire or two solid or stranded 22-gauge wires.

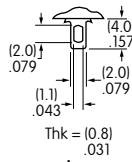

Center terminal is 0.51mm longer.

Lamp Terminals

Lamp terminals have 1.2mm diameter holes which accommodate one solid 18-gauge wire.

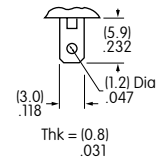

LAMP CODES & SPECIFICATIONS

Electrical specifications are determined at a basic temperature of 25°C. Lamp circuit is independent of switch operation. For dimension drawings of lamps see [Accessories & Hardware Index](#). If the source voltage is greater than rated voltage, a ballast resistor is required. The ballast resistor calculation and more lamp detail are shown in the Supplement; see [Supplement Index](#).

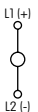

Incandescent Lamp for Solid and Design Caps

AT602 Incandescent	AT602N Neon		06	12	18	24	28	N	
		Voltage	V	6V	12V	18V	24V	28V	110V
		Current	I	80mA	50mA	35mA	25mA	22mA	1.5mA
		MSCP		.159	.215	.398	.215	.247	NA
		Endurance	Hrs	2,000 average					25,000 average
		Ambient Temp Range		-10 ~ +50°C					
		Recommended Resistor for Neon: 33K ohms for 110V AC; 100K ohms for 220V AC							
		00	No Lamp Code 00 indicates that no lamp is used.						

T-1 1/2 Pilot Slide Base



Series MLW

Snap-in Mount Power Rated Switches

LED COLORS & SPECIFICATIONS

Double Element LED

AT622 LED	Color				
	C	E	F		
	LEDs are colored in OFF state.	Red	Yellow	Green	
T-1 1/4 Pilot Slide Base	Forward Peak Current	I_{FM}	30mA	30mA	30mA
	Continuous Forward Current	I_F	20mA	20mA	20mA
	Forward Voltage	V_F	3.6V	4.2V	4.3V
	Reverse Peak Voltage	V_{RM}	8V	8V	8V
	Current Reduction Rate Above 25°C	ΔI_F	0.40mA/°C	0.32mA/°C	0.42mA/°C
	Ambient Temp Range		-10 ~ +50°C		

CAP TYPES & COLORS

For Incandescent or Neon Lamps

RA AT405
Rocker

RB

RC

RD

RE

RF

RG

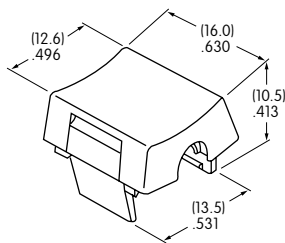

PA AT426
Paddle

PB

PC

PD

PE

PF

PG

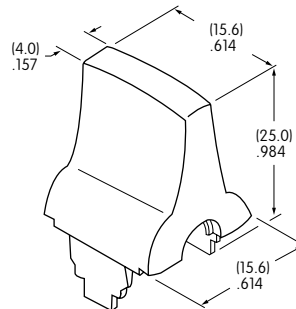

DB AT438
Design Rocker

DC

DD

DF

DG

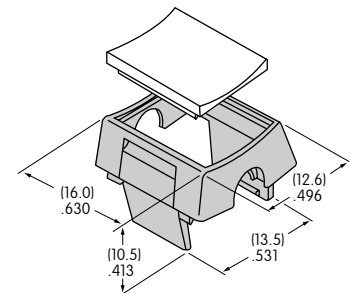

Material: Translucent Polycarbonate Standard Finish: Glossy
Black Rocker/Paddle not for use with lamp

Translucent Colored Filter
Opaque Black Rocker Base

For LED

LB AT4125
LED Rocker

LC

LE

LF

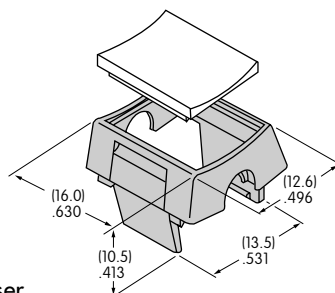

Translucent Colored Diffuser
Opaque Black Rocker Base

SB AT4127
Sculptured Rocker

SC

SE

SF

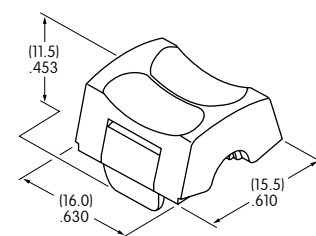

Material: Translucent Polycarbonate Standard Finish: Glossy

Color Codes: **A** Black **B** White **C** Red **D** Orange **E** Yellow **F** Green **G** Blue



Series MLW

Snap-in Mount Power Rated Switches

OPTIONAL BEZELS

AT204 20mm Wide Bezel (Standard)

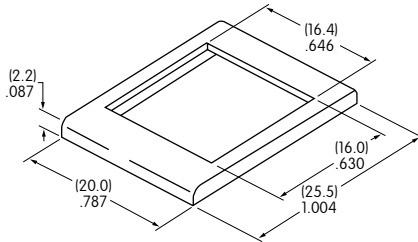
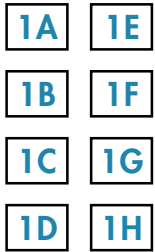

AT9201 23.8mm Wide Bezel (Large)

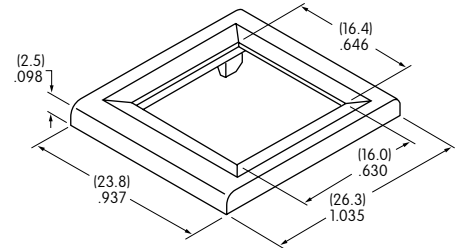

Material: Polycarbonate Standard Finish: Glossy

Color Codes: A Black B White C Red D Orange E Yellow F Green G Blue H Gray

Bezel Assembly

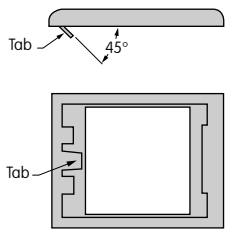

1. Pry out tab on bezel to a 45° angle.

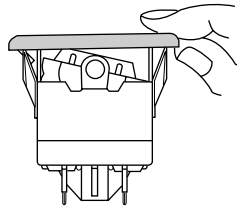

2. Insert switch frame under tab and snap on bezel.

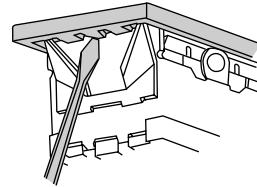

3. Push tab back into place.

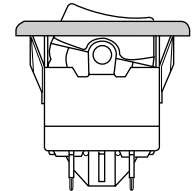

4. Snap cap onto switch.

TYPICAL SWITCH DIMENSIONS

Without Bezel

Single & Double Pole

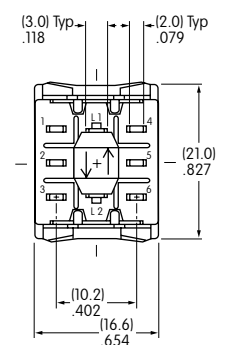
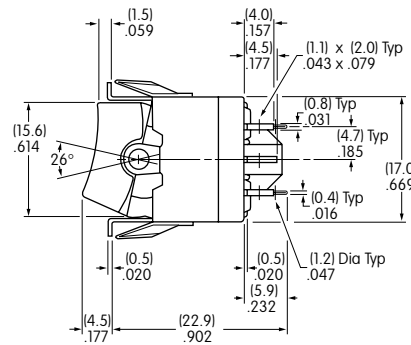
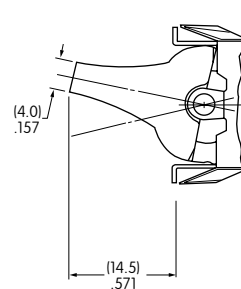
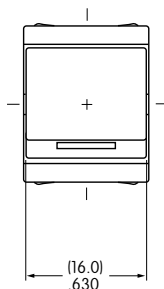

MLW3022-12PC

Actuator in UP position.

Terminals 4, 5, & 6 are not on single pole models.



Series MLW

Snap-in Mount Power Rated Switches

TYPICAL SWITCH DIMENSIONS

Standard Bezel



MLW3022-12RC-1A

Single & Double Pole

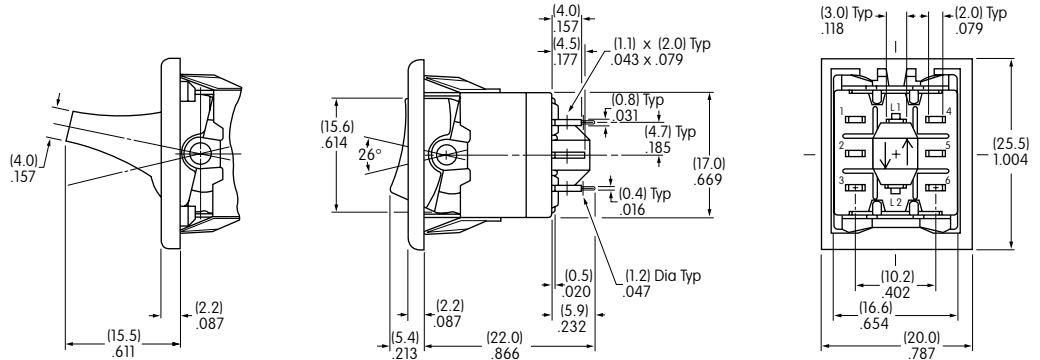

Actuator in UP position.

Terminals 4, 5, & 6 are not on single pole models.

Large Bezel



MLW3022-12PC-2A

Single & Double Pole

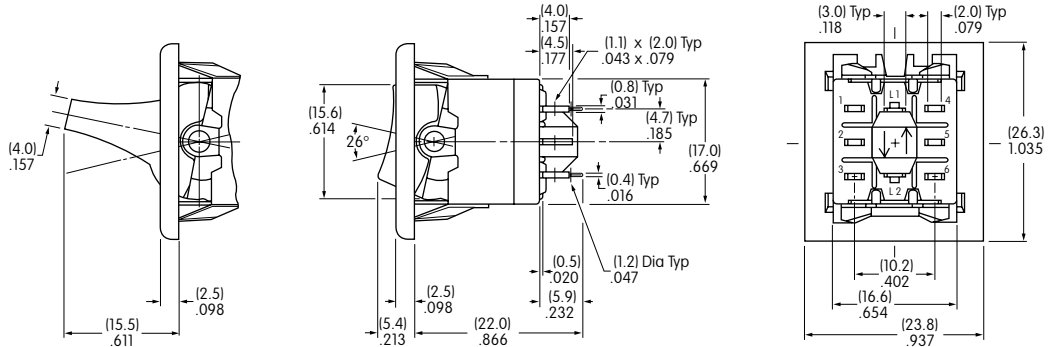

Actuator in UP position.

Terminals 4, 5, & 6 are not on single pole models.

Sculptured Cap



MLW3022-CSC-1A

Single & Double Pole

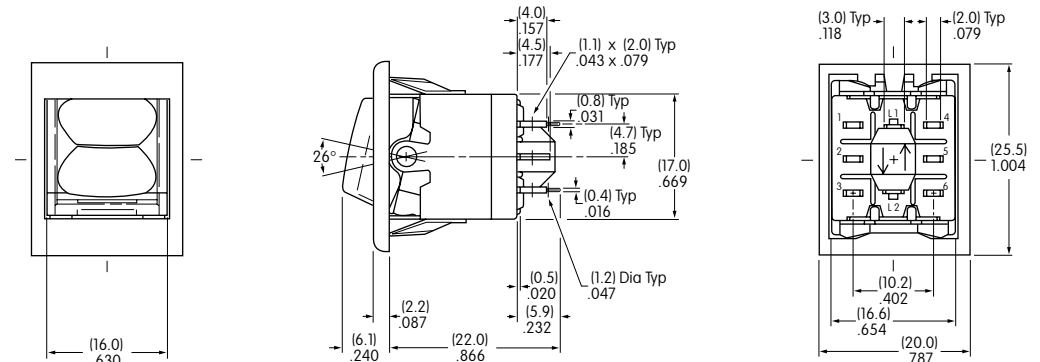

Actuator in UP position.

Terminals 4, 5, & 6 are not on single pole models.

PANEL CUTOUTS & THICKNESSES

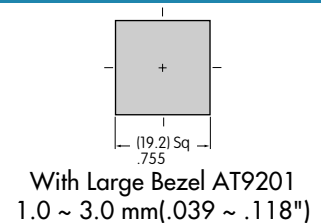
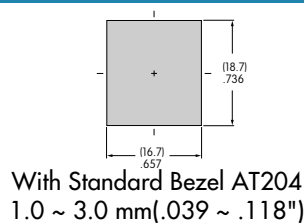
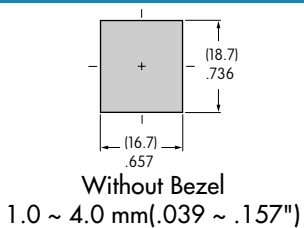



INSTALLATION & MAINTENANCE

Lamps and LEDs can be changed without removing the switch from the panel. The lamp extractor (AT107) assists in removing lamps and LEDs.

**AT107
Lamp Extractor**

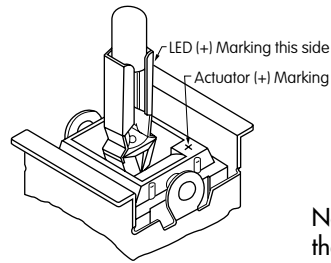
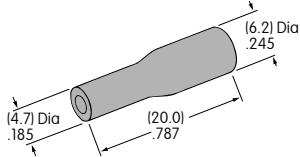

Note: When changing LEDs, match the positive polarity markings on both lamp base and actuator block.